

VOLUME 4

# SEATTLE TO LYON

FACETED AND LUMINOUS

---

LightArt

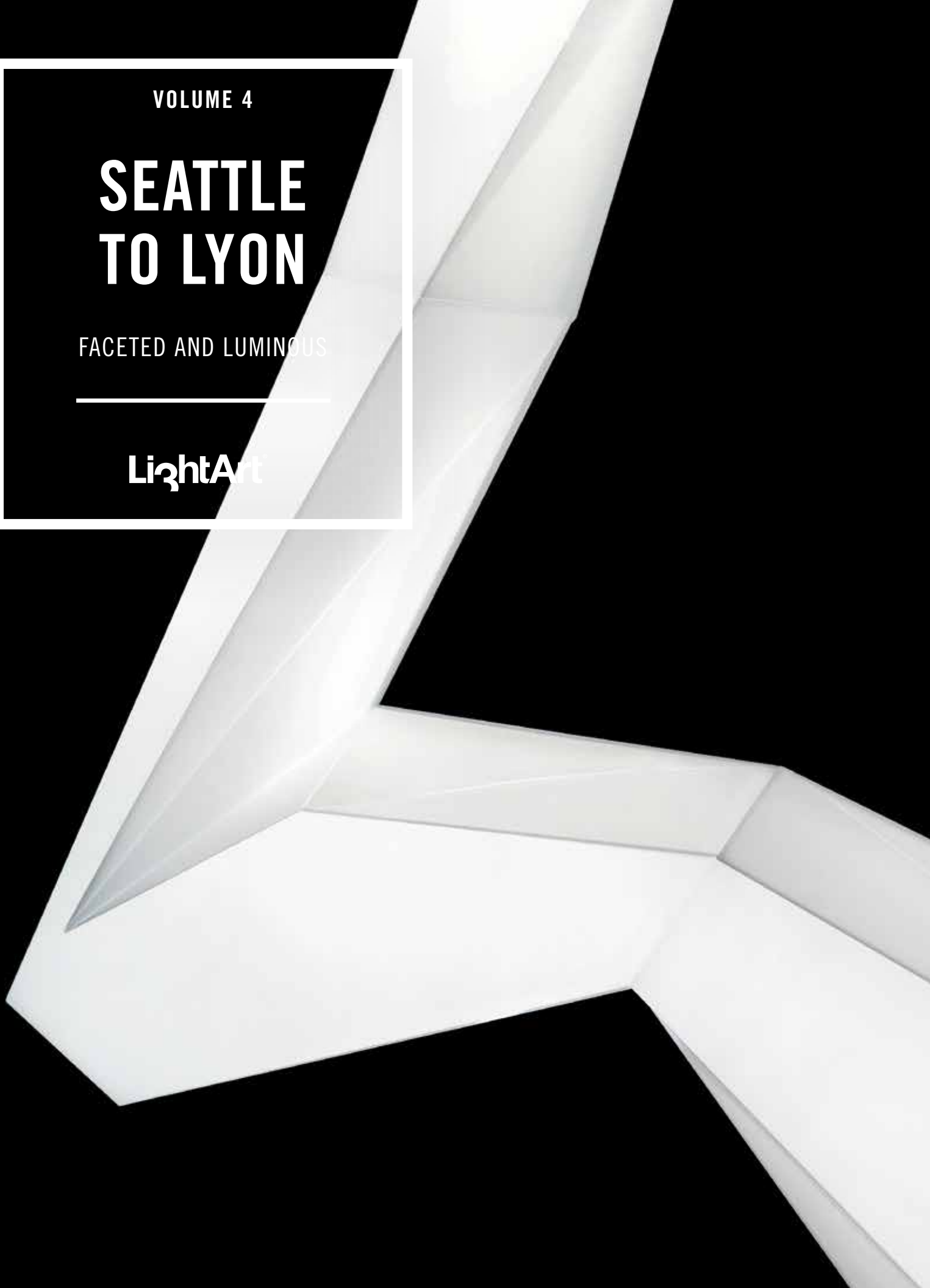



SEATTLE+



**LYON**



**A/** The design team walking to the office in Rochetoirin, France.

**B/** The team came across the Musée des Confluences in Lyon, which was the inspiration for this unique collection.



**C** / Back in Seattle, working to achieve new lines and angles with resin.

**D** / Design development in Seattle through the use of digital fabrication technology.

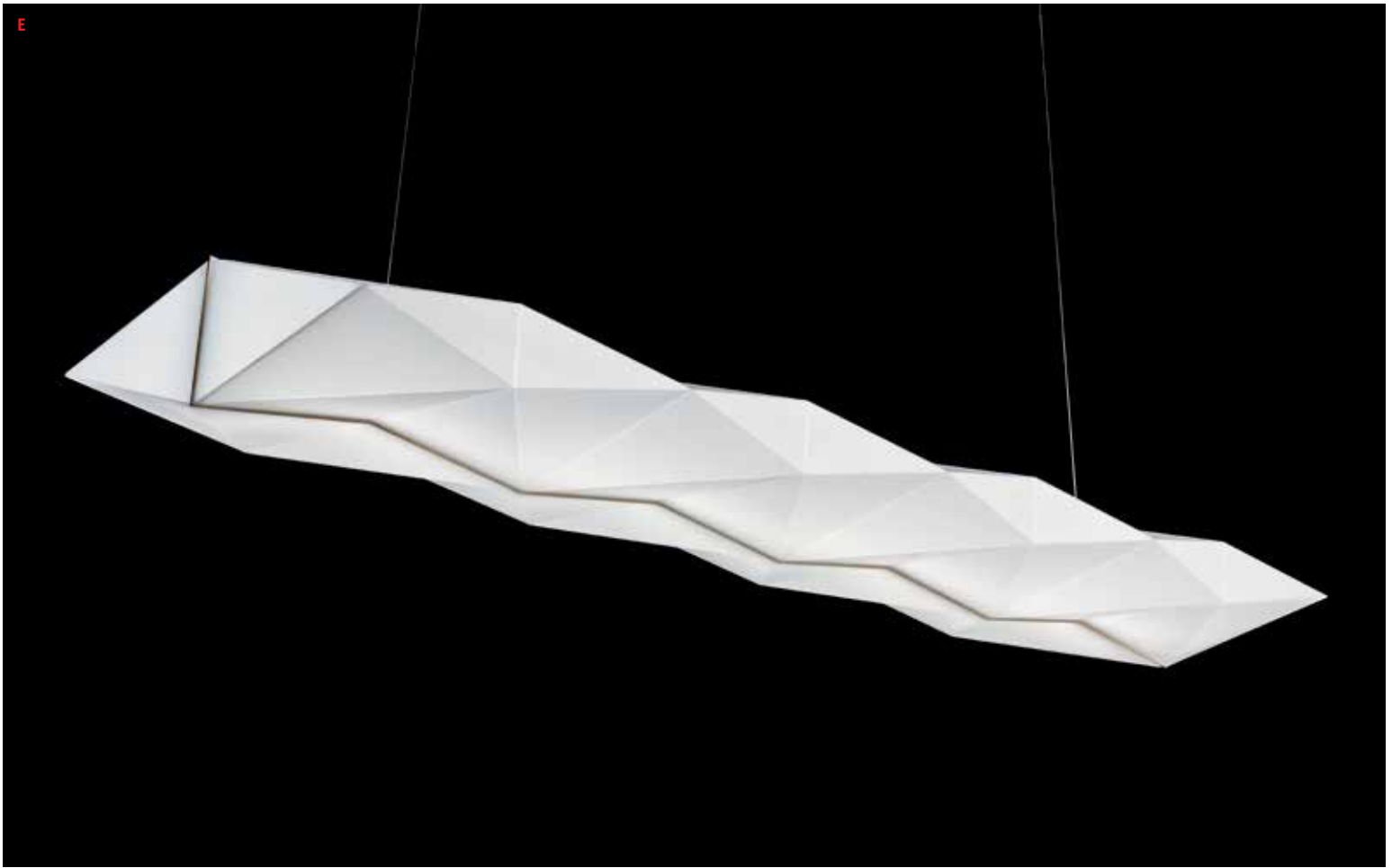

E / FIVE X, Ray

# SEATTLE + LYON CONFLUENCE

LightArt partnered with French design studio, iwoodlove, to create a new lighting collection that redefines cross-cultural collaboration and pushes the limits of digital technology.

President and Creative Director, Ryan Smith, travelled with Guillaume Martin and Michael Damen of iwoodlove to France where the trio was inspired by the remarkable architecture and geometric nature of the Musée des Confluences in Lyon.

Combining LightArt's forward-thinking LA2 technology and advanced digital fabrication techniques allowed the team of designers to carve new angles required for a unique outcome.

The result is the FIVE X Collection: an embodiment of architecture, innovation in fabrication, and cultural influence.

F



F / FIVE X, Pivot

# FIVE X COLLECTION

## PIVOT

CIRCULAR 03  
79"L x 83"W x 24"H

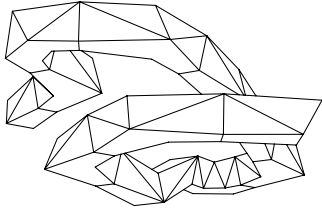

## VEX

PATTERN 03

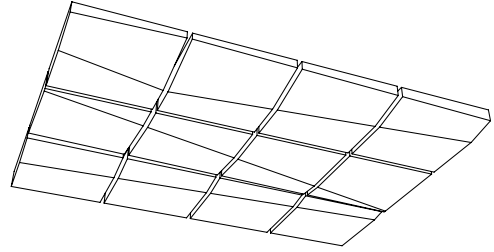

## LINEAR 01

96"L x 7.75"W x 7"H

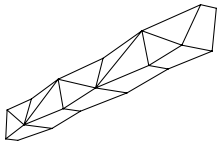

## LINEAR 03

112.25"L x 7.75"W x 15.5"H

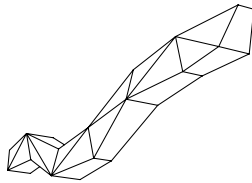

## PATTERN 05

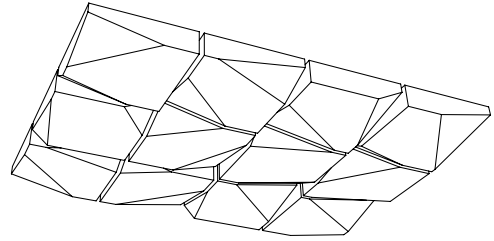

## ZIGZAG 01

130.5"L x 28"W x 7"H

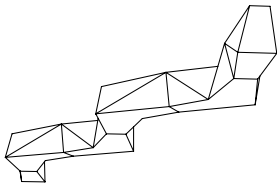

## CIRCULAR 01

110.75"L x 77.8"W x 24"H

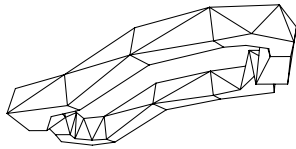

## RAY

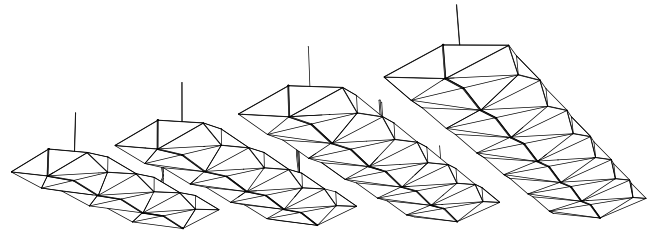

## PLOT

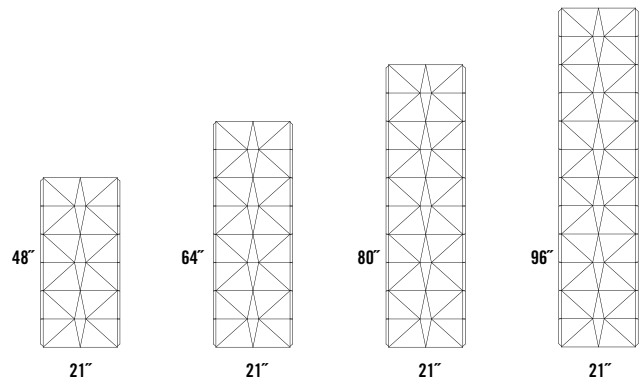
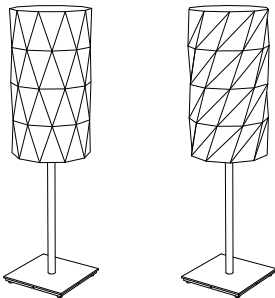

## STANDARDS

8-12 week lead time  
Adjustable 12"-96" suspension

Integrated solid state LED System  
Dimming option available  
3000K