

# SLIM RING

## LA2 SLIM RING OVERVIEW



### STANDARD DIMENSIONS *Custom options available*

SMALL  
21.5" Dia. x 2.5"D x 2.5"H

MEDIUM  
33" Dia. x 2.5"D x 2.5"H

LARGE  
43" Dia. x 2.5"D x 2.5"H

EXTRA LARGE  
57.5" Dia. x 2.5"D x 2.5"H

MATERIALS  
1/32" 3form Varia EcoResin  
White Opal diffuser  
Fixture price available upon request

## SPECIFICATIONS

### LIGHTING:

Solid State LED System

120v-277v input;  
0-10v dimming compatible

3000k, 3500k or 4000k options  
80 CRI light source

Small - 25w  
Medium - 40w  
Large - 50w  
X-Large - 71w

### HARDWARE:

Round canopy and dress plate mounts to standard  
junction box (provided by others)

S/M/L: (3) 3/64" stainless steel cables to ceiling;  
XL: (4) cables

Adjustable suspension

Power cord to canopy

### STANDARDS:

4-6 week lead time

CSA approved to UL standards

250+ 3form material options

Damp Rated

5 year limited warranty

Contact for custom material pricing



Last Updated 3.18.20

# SLIM RING

## LA2 SLIM RING FIXTURE OPTIONS

### RENDERINGS AND DIMENSIONS

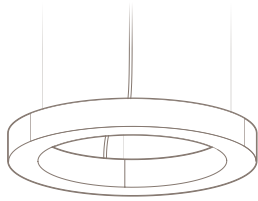

21.5" Dia. x 2.5"D x 2.5"H - 2.5lbs

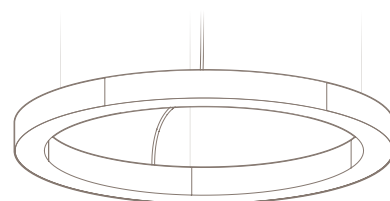

33" Dia. x 2.5"D x 2.5"H - 4.5lbs

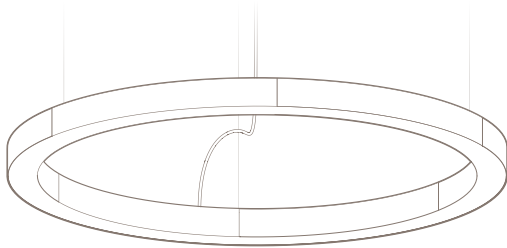

43" Dia. x 2.5"D x 2.5"H - 6lbs

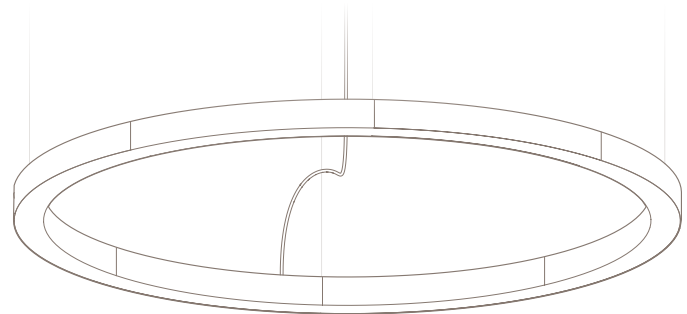

57.5" Dia. x 2.5"D x 2.5"H - 8lbs

### SHADE COLOR OPTIONS

#### 3FORM VARIA ECORESIN



Cinder



Silken Oyster



Gesso



Cranberry x2



Natural



Wizard



Vitamin C

\*Materials shown lit (left) and unlit (right)

\*Lead times subject to change

### MATERIAL OPTIONS

Hundreds of colors available!

Contact us for samples and more information.



Last Updated 3.18.20

### CANOPY / DRESS PLATE FINISH OPTIONS

#### STANDARD



White/ White

#### BY REQUEST



Silver/Silver



Black/Black

#### CEILING HARDWARE

Cables to Ceiling

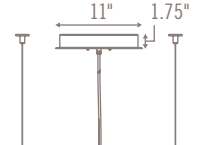
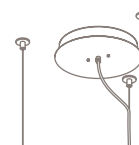

Cables to Canopy

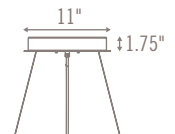

# SLIM RING

## LA2 SLIM RING PART NUMBER SPECIFICATION

Complete form to order Slim Ring fixture(s)

**SPECIFICATION CODE** Example: 2 QTY LA2-SLIM-RING-21.5-WZ-830-STD-CCL-WP-WH

Qty.  **LA2-SLIM-RING-**  -  -  -  -  -  -

1     2     3     4     5     6     7

For each number, make one selection and enter in the corresponding box above. \*Indicates modified choices; additional lead times and/or costs may apply.

### 1 SIZE

<input type="checkbox"/> 21.5	21.5" Dia
<input type="checkbox"/> 33	33" Dia
<input type="checkbox"/> 43	43" Dia
<input type="checkbox"/> 57.5	57.5" Dia

### 2 MATERIAL

<input type="checkbox"/> GO	<input type="checkbox"/> CB2	<input type="checkbox"/> GO Gesso	<input type="checkbox"/> CB2 Cranberry x2
<input type="checkbox"/> NL	<input type="checkbox"/> VC	<input type="checkbox"/> NL Natural	<input type="checkbox"/> VC Vitamin C
<input type="checkbox"/> CR	<input type="checkbox"/> WZ	<input type="checkbox"/> CR Cinder	<input type="checkbox"/> WZ Wizard
<input type="checkbox"/> SO	<input type="checkbox"/> CUST*	<input type="checkbox"/> SO Silken Oyster	<input type="checkbox"/> CUST* Custom Color

### 3 LED CRI / CCT

<input type="checkbox"/> 830	830 80 CRI / 3000K
<input type="checkbox"/> 835*	835* 80 CRI / 3500K
<input type="checkbox"/> 840*	840* 80 CRI / 4000K

### 4 SUSPENSION

<input type="checkbox"/> STD	STD 12"-96"
<input type="checkbox"/> EXT*	EXT* 12"-240"

### 5 CANOPY OPTIONS

<input type="checkbox"/> CCL	CCL Cables to Ceiling
<input type="checkbox"/> CCN*	CCN* Cables to Canopy

### 6 CANOPY COLOR

<input type="checkbox"/> WP	WP White
<input type="checkbox"/> BP*	BP* Black
<input type="checkbox"/> SP*	SP* Matte Silver

### 7 POWER CORD

<input type="checkbox"/> WH	WH White
<input type="checkbox"/> BK*	BK* Black

\*Indicates modified choices; additional lead times and/or costs may apply.



Last Updated 3.18.20